



DC Input Dual
Optocoupler

ELECTRICAL CHARACTERISTICS - 25°

PARAMETER	UNIT	MIN	TYP	MAX	TEST CONDITIONS
INPUT SPECIFICATIONS					
LED Forward Voltage	V		1.2	1.4	If = 10mA
Peak Forward Voltage	V			3	Ifm = 0.5A
Reverse Current	μ A			10	Vr=4V
OUTPUT SPECIFICATIONS					
Collector-Emitter Breakdown Voltage	V	60			Ic = 10uA
Emitter-Collector Breakdown Voltage	V	6			Ie = 10uA
Dark Current	μ A			0.1	Vce = 20V
Floating Capacitance	p F		0.6	1	Vce = 0V, f=1.0MHz
Saturation Voltage	V		0.1	0.2	If = 20mA, Ic = 1mA
Current Transfer Ratio	%	50		600	If = 5mA, Vce = 5V
Rise Time	μ s		4		Ic = 2mA, Vce = 2V, Rc =100 ohms
Fall Time	μ s		3		Ic = 2mA, Vcc = 2V, Rc = 100 ohms
COUPLED SPECIFICATIONS					
Isolation Voltage	V	5000			T = 1 minute
Isolation Resistance	G Ω	50			DC500V



Fig.1 Current Transfer Ratio vs. Forward Current

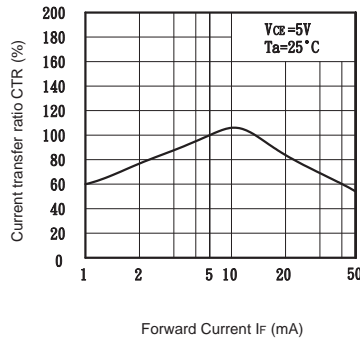

Fig.2 Collector Power Dissipation vs. Ambient Temperature

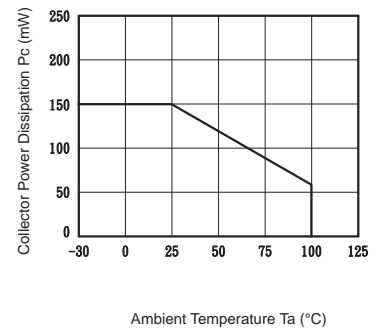

Fig.3 Collector Dark Current vs. Ambient Temperature

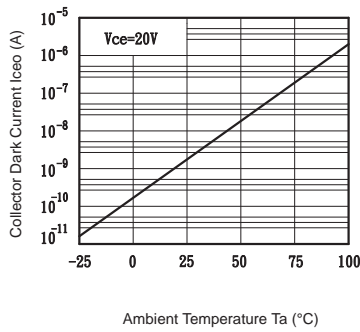

Fig.4 Forward Current vs. Ambient Temperature

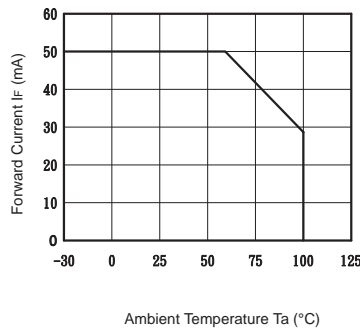

Fig.5 Forward Current vs. Forward Voltage

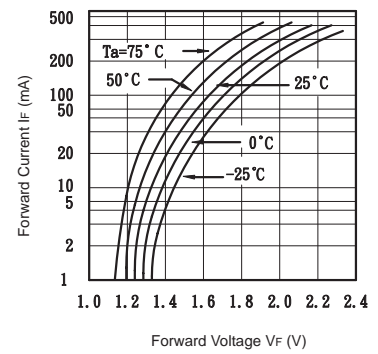

Fig.6 Collector Current vs. Collector-emitter Voltage

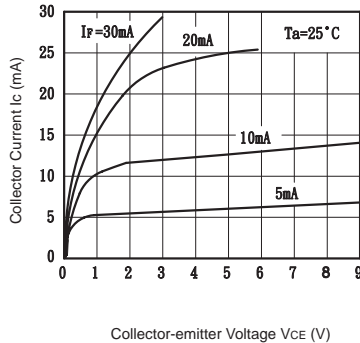

Fig.7 Relative Current Transfer Ratio vs. Ambient Temperature

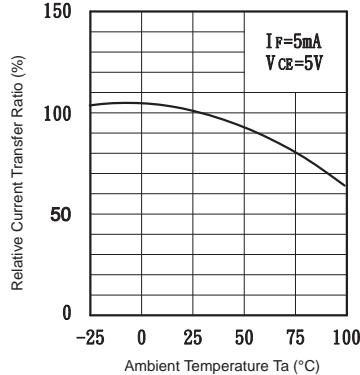

Fig.8 Collector-emitter Saturation Voltage vs. Ambient Temperature

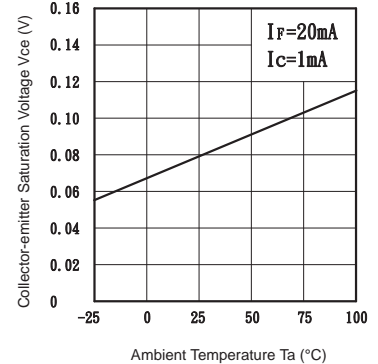

Fig.9 Collector-emitter Saturation Voltage vs. Forward Current

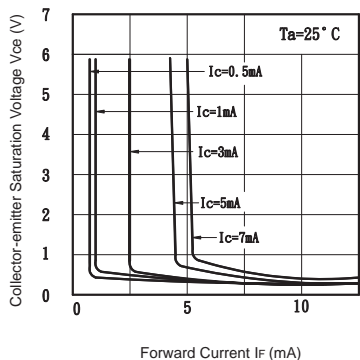

Fig.10 Response Time vs. Load Resistance

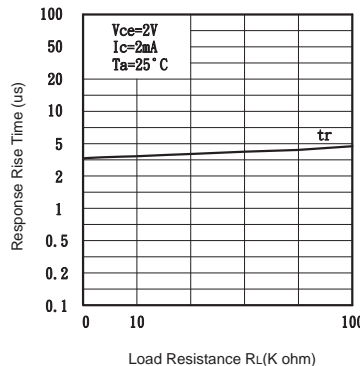
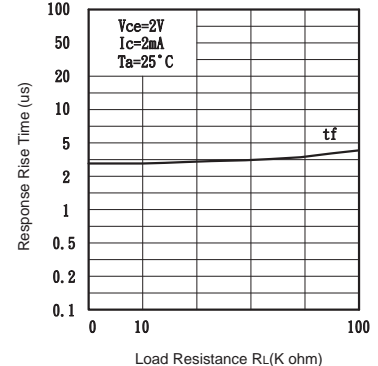

Fig.11 Response Time vs. Load Resistance





DC Input Dual
Optocoupler

MECHANICAL DIMENSIONS

8 PIN DUAL IN-LINE PACKAGE

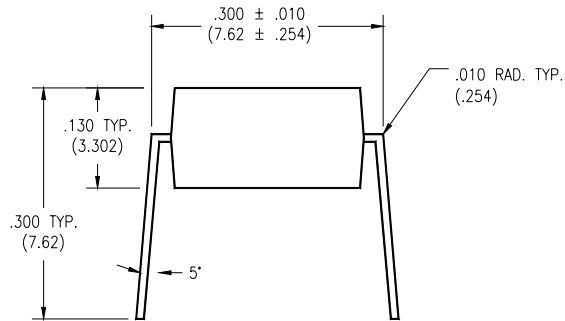

END VIEW

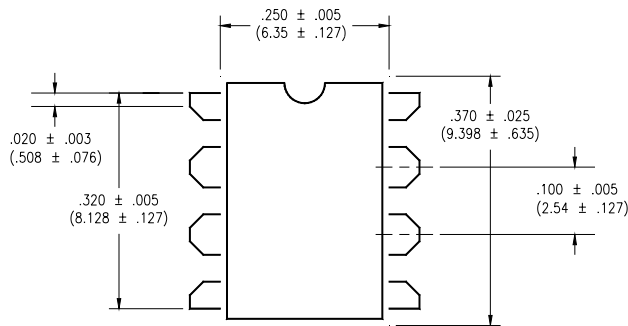

TOP VIEW

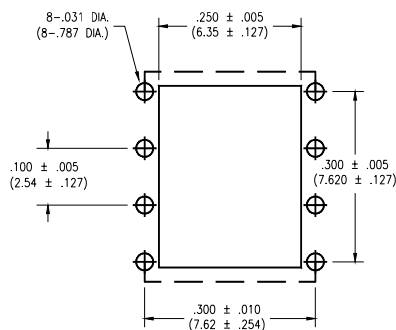

**BOTTOM VIEW/
BOARD PATTERN**

8 PIN SURFACE MOUNT DEVICE

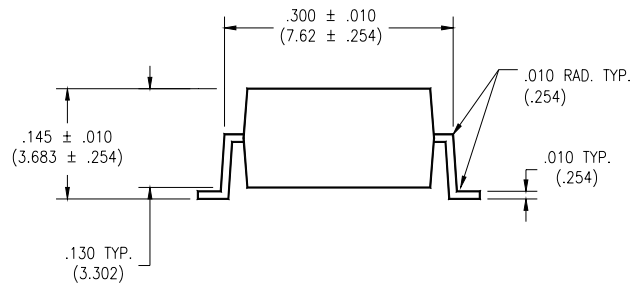

END VIEW

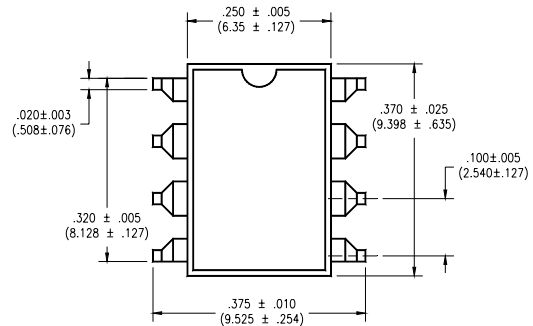

TOP VIEW

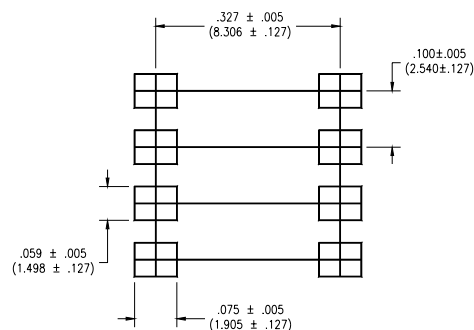

**BOTTOM VIEW/
BOARD PATTERN**