



DESCRIPTION

The SDD1600 combines four independent optocouplers in a 16 pin DIP/SMD package. Each of the four optocoupler circuits is composed of an input LED optically-coupled to a Photo Darlington Transistor--allowing for high isolation levels while maintaining low-level DC signal control capability. The SDD1600 provides an optically isolated method of controlling many interface applications such as telecommunications, industrial control and instrumentation circuitry.

FEATURES

- High current transfer ratio
- High input-to-output isolation package (5000 Vrms)
- Compact dual-in-line package

APPLICATIONS

- System appliances, measuring instruments
- Industrial robots
- Copiers, automated vending machines
- Signal transmission between varying circuits
- Telephone sets
- Fax machines
- Interface with various power supply circuits
- Numerical control machines

OPTIONS/SUFFIXES

- -S Surface Mount Option
- -TR Tape and Reel Option

SCHEMATIC DIAGRAM

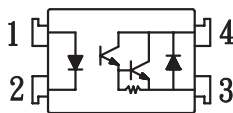

1, 3, 5 & 7: Anode
2, 4, 6 & 8: Cathode
9, 11, 13, 15: Emitter
10, 12, 14 & 16: Collector

MAXIMUM RATINGS

PARAMETER	UNIT	MIN	TYP	MAX
Storage Temperature	°C	-55		125
Operating Temperature	°C	-40		100
Continuous Forward Current	mA			50
Peak Forward Current	A			1
Reverse Voltage	V			6
Output Power Dissipation	mW			200

APPROVALS

- UL and C-UL Approved, File #E201932



DC Input
Optocoupler

ELECTRICAL CHARACTERISTICS - 25°

PARAMETER	UNIT	MIN	TYP	MAX	TEST CONDITIONS
INPUT SPECIFICATIONS					
LED Forward Voltage	V		1.2	1.4	If = 20mA
Reverse Current	μ A			10	Vr=4V
Terminal Capacitance	p F		30		V=0, f=1kHz
OUTPUT SPECIFICATIONS					
Collector-Emitter Breakdown Voltage	V	300			Ic = 10uA
Emitter-Collector Voltage	V	0.1			Ie = 10uA
Dark Current	μ A			1	Vce = 200V, If=0
Floating Capacitance	p F		0.6	1	Vce = 0V, f=1.0MHz
Saturation Voltage	V			1.5	If = 20mA, Ic = 5mA
Current Transfer Ratio	%	600		9000	If = 1mA, Vce = 2V
Rise Time	μ s		60		Ic = 20mA, Vce = 2V, Rc = 100 ohms
Fall Time	μ s		50		Ic = 20mA, Vce = 2V, Rc = 100 ohms
COUPLED SPECIFICATIONS					
Isolation Voltage	V	5000			T = 1 minute
Isolation Resistance	G Ω	50			
Cut off Frequency	k H z		7		Ic = 2mA, Vcc = 5V, Rc = 100 ohms



Fig.1 Current Transfer Ratio vs. Forward Current

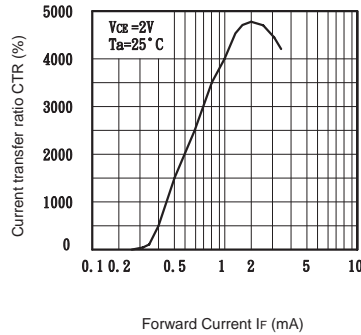

Fig.2 Collector Power Dissipation vs. Ambient Temperature

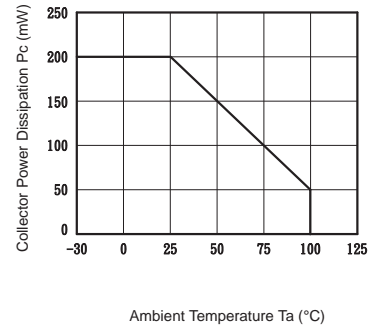

Fig.3 Collector Dark Current vs. Ambient Temperature

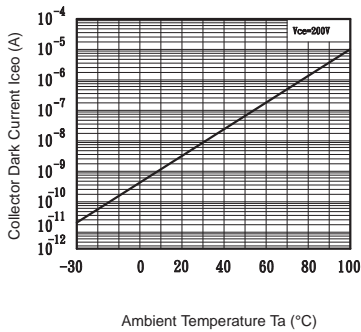

Fig.4 Forward Current vs. Ambient Temperature

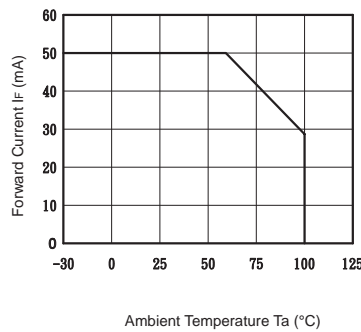

Fig.5 Forward Current vs. Forward Voltage

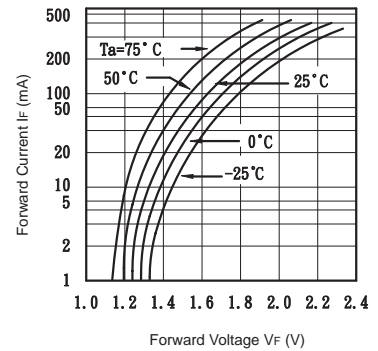

Fig.6 Collector Current vs. Collector-emitter Voltage

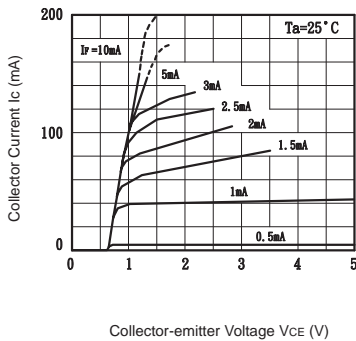

Fig.7 Relative Current Transfer Ratio vs. Ambient Temperature

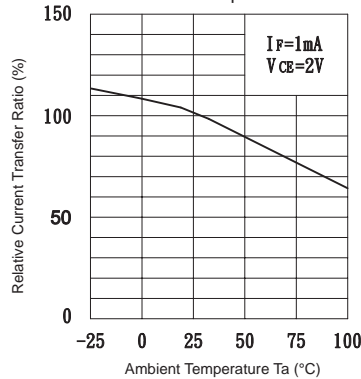

Fig.8 Collector-emitter Saturation Voltage vs. Forward Current

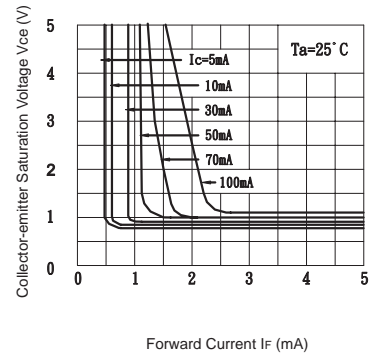
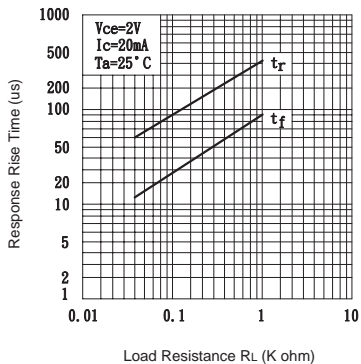

Fig.9 Response Time vs. Load Resistance



DC Input
Quad Optocoupler



MECHANICAL DIMENSIONS

16 PIN DUAL IN-LINE PACKAGE

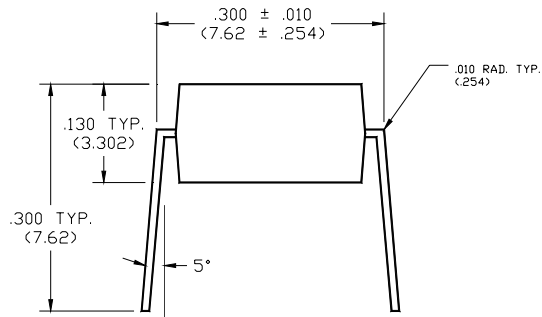

END VIEW

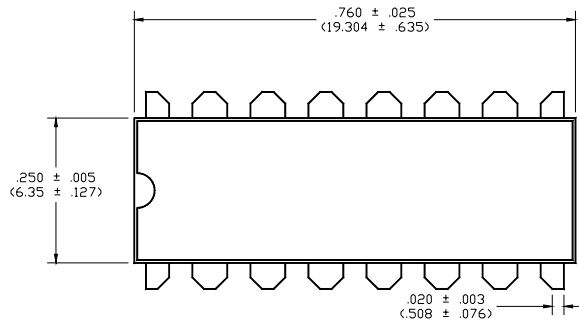

TOP VIEW

16 PIN SURFACE MOUNT DEVICE

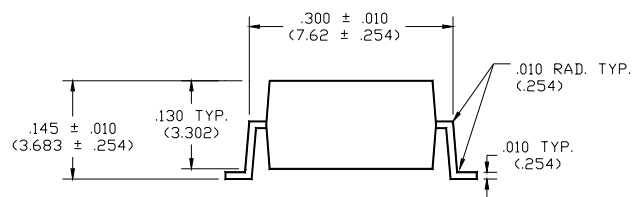

END VIEW

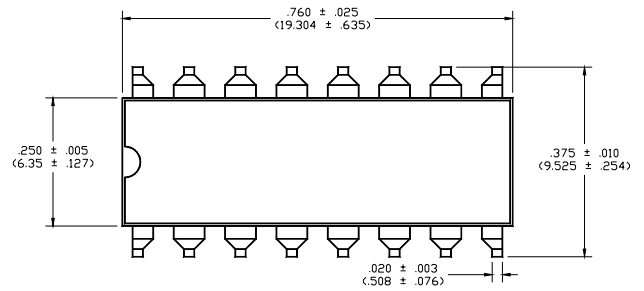

TOP VIEW